



NF Walker 2 / centrale loophulp



made for movement | Authorised Distributor

Anvrager / Dealer:

Besteldatum:

Adres:

Ordernummer:

Postcode / Plaats:

Referentie:

Contactpersoon:

Telefoonnummer:



De NF-Walker 2 biedt een kind de mogelijkheid om zelf de wereld te onderzoeken in een veilige, gecontroleerde houding. De lichaamsbrace met bijbehorende braceclips zorgen ervoor dat een kind met het lichaamsgewicht op de voeten rust. Door middel van de meegeleverde elastieken en diverse opties en accessoires kan een loopbeweging gestimuleerd worden.

Standaard uitvoering voorzien van:

- Standaard onderstel met vering
- Begeleider handvat
- Lichaamsbrace met rompband, bekkenband, en kuitbanden
- Rompband polstering
- Heupscharnier met abductiemogelijkheid
- Elastieken t.b.v. dynamische loonondersteuning
- Voorwielen met rijrichtingsfixatie en Stootrollen
- Achterwielen met parkeerrem

Maten - Uitvoeringen

	Maat XS met Micro-kit	Maat XS	Maat S
Lichaamslengte	70 - 85 cm	80 - 110 cm	100 - 140 cm
Heupbreedte	15,5 - 23 cm	15,5 - 23 cm	17,7 - 29 cm
A Romphoogte (heup tot oksel)	13,5 - 28 cm	13,5 - 28 cm	18 - 33 cm
B Bovenbeenlengte (knie tot heup)	13 - 22 cm	16 - 26 cm	21,3 - 34,5 cm
C Onderbeenlengte (enkel tot knie)	14,2 - 22 cm	16 - 26 cm	21,3 - 34,5 cm
Maximale belasting	30 kg	30 kg	40 kg

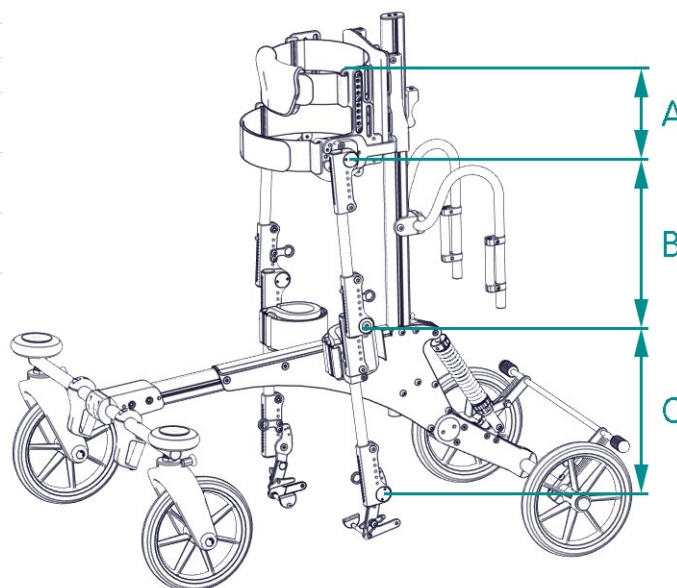

NF-WALKER 2







NF Walker 2 / centrale loophulp



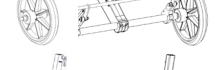

Uitvoeringen

	Bestelcode	Omschrijving	Bruto Excl.	BTW
NF-WALKER ²	MA-301272/NL	NF-Walker 2 XS	€ 8.270,00	L
	MA-301274/NL	NF-Walker 2 S	€ 8.730,00	L

Onderstel opties

	Bestelcode	Omschrijving	Voor maat	Bruto Excl.	BTW
	MA-301563	Micro-kit uitvoering (voor lichaamslengte 70 - 85 cm)	XS	€ 62,50	L
	MA-301851	In hoogte verstelbare kolom	S	€ 800,00	L
	MA-301984	Voorwielas, breed	S	€ 42,50	L
	MA-301199	Achterwiel met terugloopberemming (per stuk)	XS + S	€ 60,00	L
	MA-301564	Stuursysteem compleet, standaard (alleen i.c.m. T-handvat)	XS + S	€ 562,50	L
	MA-301565	Stuursysteem compleet, breed (alleen i.c.m. T-handvat)	XS + S	€ 600,00	L

Hoofdsteunen

	Bestelcode	Omschrijving	Voor maat	Bruto Excl.	BTW
	MA-301442	Hoofdsteun inclusief boog	XS + S	€ 475,00	L
	MA-301393	Hoofdsteun inclusief extra lange boog	XS + S	€ 487,50	L
	MA-105067	Nekbrace, small	XS + S	€ 254,80	L
	MA-105066	Nekbrace, medium	XS + S	€ 261,43	L
	MA-105065	Nekbrace, large	XS + S	€ 265,40	L

Rompondersteuning

	Bestelcode	Omschrijving	Voor maat	Bruto Excl.	BTW
	MA-103587	Lordose ondersteuning, small	XS + S	€ 177,50	L
	MA-101788	Lordose ondersteuning, medium	XS + S	€ 202,50	L
	MA-101789	Lordose ondersteuning, large	XS + S	€ 289,28	L

Armondersteuning

	Bestelcode	Omschrijving	Voor maat	Bruto Excl.	BTW
	MA-302122	Bevestiging blok voor handvat en-/of blad voor XS met Micro kit	Micro	€ 595,00	L
	MA-301194	Bevestiging blok voor handvat en-/of blad	XS + S	€ 522,50	L



NF Walker 2 / centrale loophulp







 made for
movement | Authorised
Distributor

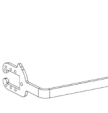
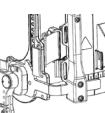

Armondersteuning

	Bestelcode	Omschrijving	Voor maat	Bruto Excl.	BTW
	MA-301196	Handvat, standaard (alleen i.c.m. bevestiging blok of stuursysteem)	XS + S	€ 112,50	L
	MA-301197	Handvat, breed (alleen i.c.m. bevestiging blok of stuursysteem)	XS + S	€ 117,50	L
	MA-302413	Blad Micro (alleen i.c.m. Bevestiging blok voor XS met Micro kit)	Micro	€ 645,00	L
	MA-301193	Blad (alleen i.c.m. Bevestiging blok)	XS + S	€ 685,00	L
	MA-301193	Blad polstering, 5cm dik (alleen i.c.m. blad)	XS + S	€ 247,50	L
	MA-301208	Laterale handgrepen, compleet (paar)	XS + S	€ 500,00	L
	MA-301149	Handfixatie maat Small (paar)	XS + S	€ 60,00	L
	MA-301363	Handfixatie maat Medium (paar)	XS + S	€ 62,50	L
	MA-301364	Handfixatie maat Large (paar)	XS + S	€ 65,00	L

Brace opties

	Bestelcode	Omschrijving	Voor maat	Bruto Excl.	BTW
	MA-301166	Polsteringsset t.b.v. bekkenband	XS + S	€ 173,50	L
	MA-100158	SIAS-pelot t.b.v. bekkenband (per stuk)	XS + S	€ 33,28	L
	MA-301505	Heupboog breed, links	S	€ 237,50	L
	MA-301506	Heupboog breed, rechts	S	€ 237,50	L
	MA-301559	Brace rotatie systeem, links	S	€ 337,50	L
	MA-301560	Brace rotatie systeem, rechts	S	€ 337,50	L
	MA-301394	Brace rotatie systeem, paar	S	€ 675,00	L

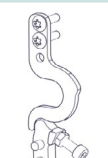
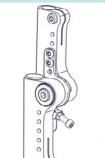
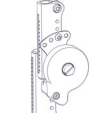
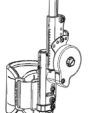
Knieschermier opties

	Bestelcode	Omschrijving	Voor maat	Bruto Excl.	BTW
	MA-301141	Knie overstrekk beschermers links, voor maat XS	XS	€ 125,00	L
	MA-301142	Knie overstrekk beschermers rechts, voor maat XS	XS	€ 125,00	L
	MA-301139	Knie overstrekk beschermers links, voor maat S	S	€ 125,00	L
	MA-301140	Knie overstrekk beschermers rechts, voor maat S	S	€ 125,00	L
	MA-301557	Dynamisch knie extensie systeem links	S	€ 275,00	L
	MA-301558	Dynamisch knie extensie systeem rechts	S	€ 275,00	L
	MA-301395	Dynamisch knie extensie systeem, paar	S	€ 550,00	L

Geldig van 1-1-2019 t/m 31-12-2019

Prijzen onder voorbehoud van drukfouten. Getoonde afbeeldingen kunnen van de werkelijkheid afwijken.

Versie 2019-02.10



NF Walker 2 / centrale loophulp



 made for
movement | Authorised
Distributor

Accessoires

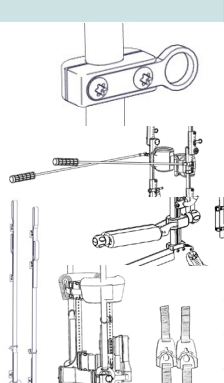
	Bestelcode	Omschrijving	Voor maat	Bruto Excl.	BTW
	MA-301145	Ring klem voor maat XS	XS	€ 137,50	L
	MA-301144	Ring klem voor maat S	S	€ 142,50	L
	MA-301203	Geleiderstang 70 cm. Compleet (per stuk)	XS + S	€ 162,50	L
	MA-301204	Geleiderstang 90 cm. Compleet (per stuk)	XS + S	€ 185,00	L
	MA-302383	In- / uitstap zitting model 2, voor NF-walker 2	XS + S	€ 680,00	L
	MA-301143	Tilbanden compleet (paar)	XS + S	€ 320,00	L
	HU-G 202-6621	Afneembare clips met karabijnhaken (Set)	XS + S	€ 156,00	L

Braceclip Sandaal

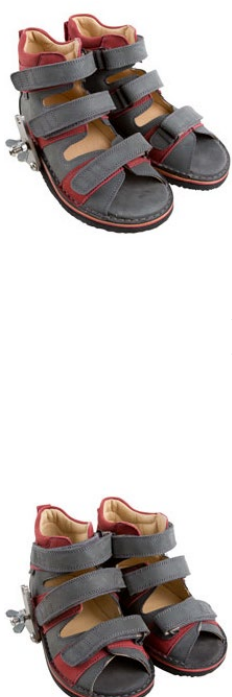
	Bestelcode	Omschrijving	Bruto Excl.	BTW	
	MA-102764	Braceclip, Sandaal, maat 18	€ 349,00	L	
	MA-100856	Braceclip, Sandaal, maat 20	€ 349,00	L	
	MA-100858	Braceclip, Sandaal, maat 22	€ 349,00	L	
	MA-100860	Braceclip, Sandaal, maat 24	€ 349,00	L	
	MA-100862	Braceclip, Sandaal, maat 26	€ 349,00	L	
	MA-102717	Braceclip, Sandaal, maat 28	€ 349,00	L	
	MA-102719	Braceclip, Sandaal, maat 30	€ 349,00	L	
	MA-102772	Braceclip, Sandaal, maat 32	€ 349,00	L	
	MA-102850	Braceclip, Sandaal, maat 34	€ 349,00	L	
	MA-102787	Braceclip, Sandaal, maat 36	€ 349,00	L	
	MA-102853	Braceclip, Sandaal, maat 38	€ 349,00	L	
	MA-105201	Braceclip, Sandaal, maat 40	€ 349,00	L	
	MA-105203	Braceclip, Sandaal EVO, maat 18	€ 349,00	L	
	MA-105205	Braceclip, Sandaal EVO, maat 20	€ 349,00	L	
	MA-105207	Braceclip, Sandaal EVO, maat 22	€ 349,00	L	
	MA-105209	Braceclip, Sandaal EVO, maat 24	€ 349,00	L	
	MA-105211	Braceclip, Sandaal EVO, maat 26	€ 349,00	L	
	MA-105213	Braceclip, Sandaal EVO, maat 28	€ 349,00	L	
	MA-105215	Braceclip, Sandaal EVO, maat 30	€ 349,00	L	
	MA-105217	Braceclip, Sandaal EVO, maat 32	€ 349,00	L	
	MA-105219	Braceclip, Sandaal EVO, maat 34	€ 349,00	L	
	MA-105221	Braceclip, Sandaal EVO, maat 36	€ 349,00	L	
	MA-105223	Braceclip, Sandaal EVO, maat 38	€ 349,00	L	
	MA-105225	Braceclip, Sandaal EVO, maat 40	€ 349,00	L	

Geldig van 1-1-2019 t/m 31-12-2019

Prijzen onder voorbehoud van drukfouten. Getoonde afbeeldingen kunnen van de werkelijkheid afwijken.

Versie 2019-02.10





NF Walker 2 / centrale loophulp



 made for
movement | Authorised
Distributor

Braceclip model schoen

	Bestelcode	Omschrijving	Bruto Excl.	BTW	
	MA-105226	Braceclip, Schoen, maat 18	€ 349,00	L	
	MA-105228	Braceclip, Schoen, maat 20	€ 349,00	L	
	MA-105230	Braceclip, Schoen, maat 22	€ 349,00	L	
	MA-105232	Braceclip, Schoen, maat 24	€ 349,00	L	
	MA-105234	Braceclip, Schoen, maat 26	€ 349,00	L	
	MA-105236	Braceclip, Schoen, maat 28	€ 349,00	L	
	MA-105238	Braceclip, Schoen, maat 30	€ 349,00	L	
	MA-105240	Braceclip, Schoen, maat 32	€ 349,00	L	
	MA-105242	Braceclip, Schoen, maat 34	€ 349,00	L	
	MA-105244	Braceclip, Schoen, maat 36	€ 349,00	L	
	MA-105246	Braceclip, Schoen, maat 38	€ 349,00	L	
	MA-105248	Braceclip, Schoen, maat 40	€ 349,00	L	
		MA-105249	Braceclip, Schoen EVO, maat 18	€ 349,00	L
		MA-105251	Braceclip, Schoen EVO, maat 20	€ 349,00	L
MA-105253		Braceclip, Schoen EVO, maat 22	€ 349,00	L	
MA-105255		Braceclip, Schoen EVO, maat 24	€ 349,00	L	
MA-105257		Braceclip, Schoen EVO, maat 26	€ 349,00	L	
MA-105259		Braceclip, Schoen EVO, maat 28	€ 349,00	L	
MA-105261		Braceclip, Schoen EVO, maat 30	€ 349,00	L	
MA-105263		Braceclip, Schoen EVO, maat 32	€ 349,00	L	
MA-105265		Braceclip, Schoen EVO, maat 34	€ 349,00	L	
MA-105267		Braceclip, Schoen EVO, maat 36	€ 349,00	L	
	MA-105269	Braceclip, Schoen EVO, maat 38	€ 349,00	L	
	MA-105271	Braceclip, Schoen EVO, maat 40	€ 349,00	L	
	MA-100165	Zoolverdikking t.b.v. compensatie beenlengteverschil (per cm) Geef kant en dikte van opvulling aan:	€ 70,68	L	